

IXA-3NNN45

IXA-4NNN45

Battery-less Absolute Arm Length: **450mm** Vertical Axis: **180/330mm**

Model Specification Items

IXA	-		NNN		45				T2	
Series		Number of axes	Type	Arm length	Vertical stroke		Cable length		Applicable controller	Option
		3 3 axes	NNN Standard type	45 450mm	18 180mm	33 330mm	N Nil	T2 XSEL-RAX/SAX	See below	
		4 4 axes					5L 5m			
							10L 10m			
							<input type="checkbox"/> L Specified length (1m increments)			

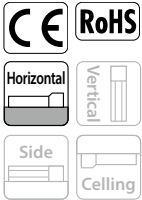

- POINT Selection Notes**
- (1) Please refer to P51 for Notes 1 - 9.
 - (2) The maximum set value for acceleration/deceleration varies depending on the weight of the object being transported, the travel distance, and the location. For continuous operation, either lower the acceleration/deceleration values or refer to the duty (guideline) and set a stop time after acceleration/deceleration.
 - (3) If the motor is replaced, absolute reset must be performed. An adjustment jig will be required to perform an absolute reset on the rotational axis (4th axis). Please refer to P53 for details.
 - (4) A continuous operation cannot be performed for SCARA robots at 100% of speed and acceleration. Refer to the "Acceleration/Deceleration Setting Guidelines" for executable operating conditions.

Option		
Name	Model number	Reference page
LED pilot lamp	LED	53

Option		
Name	Model number	Reference page
Flange	IX-FL-1	53

(Note) Please purchase separately.

Cable length			
Type	Cable code	3-axis specification	4-axis specification
Standard type	5L(5m)	<input type="checkbox"/>	<input type="checkbox"/>
	10L(10m)	<input type="checkbox"/>	<input type="checkbox"/>
	1L(1m) ~ 4L(4m)	<input type="checkbox"/>	<input type="checkbox"/>
Specified length	6L(6m) ~ 9L(9m)	<input type="checkbox"/>	<input type="checkbox"/>
	11L(11m)	<input type="checkbox"/>	<input type="checkbox"/>
	12L(12m)	<input type="checkbox"/>	<input type="checkbox"/>
	13L(13m)	<input type="checkbox"/>	<input type="checkbox"/>
	14L(14m)	<input type="checkbox"/>	<input type="checkbox"/>
	15L(15m)	<input type="checkbox"/>	<input type="checkbox"/>

(Note) Total amount of the following cables:
 [3-axis spec.] Motor cables:3, Encoder cables: 3, Brake cable: 1
 [4-axis spec.] Motor cables:4, Encoder cables: 4, Brake cable: 1

Cycle time	
Item	Time
Standard cycle time	0.38 seconds
Continuous cycle time	0.55 seconds

The standard/continuous cycle time represents the time required when an operation is performed with a cycle operation setting at maximum speed, under the following conditions.
 2kg transport, vertical movement 25mm, horizontal movement 300mm (rough positioning arch motion)
 [Standard cycle time]
 The time required for maximum speed. This is a general guideline for high speed performance.
 Note that continuous operation is not possible under maximum speed operation.
 [Continuous cycle time]
 The cycle time for continuous operation.

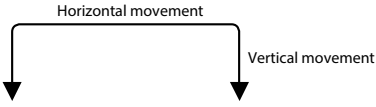

Main specifications

Item	Description		
	3-axis specification	4-axis specification	
Max. payload (kg) (Note 1)	3		
Speed (Note 2)	Combined max. speed (mm/s)	7453	
	Max. speed of individual axes	1st arm (deg/s)	610
		2nd arm (deg/s)	610
		Vertical axis (mm/s)	1200
		Rotational axis (deg/s)	— 2000
Push force (N) (Note 3)	Upper limit	55	
	Lower limit	10	
Arm length (mm)	450		
Individual arm length (mm)	1st arm	200	
	2nd arm	250	
Operation range of individual axes	1st arm (deg)	±137	
	2nd arm (deg)	±137	
	Vertical axis (mm)	180/330	
	Rotational axis (deg)	— ±360	

Item	Description	
	3-axis specification	4-axis specification
Positioning repeatability (Note 4)	Within horizontal surface	±0.01mm
	Vertical axis	±0.01mm
	Rotational axis	— ±0.005 degrees
User wiring	10-core (9-core + shield) AWG24 (rated 30V/Max. 1A)	
User piping	Outer diameter Φ6, inner diameter Φ4, air tube 3 pcs. (max. usable pressure 0.6MPa)	
Alarm lamp (Note 5)	Amber color LED, small pilot lamp 1 pc. (DC24V supply required)	
Brake release switch (Note 6)	Brake release switch for preventing vertical axis from dropping.	
Tip axis	Allowable torque	3.2 N·m 3.2 N·m
	Allowable load moment	8.3 N·m
Ambient operational temperature and humidity	0-40°C, 20-85% RH or lower (non-condensing)	
Degree of protection	IP20	
Vibration- and impact-resistance	No impact or vibration should be applied.	
Noise (Note 7)	80 dB or lower	
International standard	CE marking, RoHS	
Motor type	AC servo motor	
Motor wattage	1st arm	400W
	2nd arm	200W
	Vertical axis	100W
	Rotational axis	— 100W
Encoder type	Battery-less absolute	
Encoder pulse	16384 pulse/rev	

Tip shaft allowable load inertia moment

Number of axes	Tip shaft allowable load inertia moment
3-axis specification	0.05 kg · m ²
4-axis specification	

The 4th axis allowable inertia moment is the allowable inertial moment value for the center of rotation conversion of the 4th axis (rotational axis) of the SCARA robot. Make sure that the offset value from center of the rotation of the 4th axis to the tool center of gravity is within the guideline values listed below. If the tool center of gravity is far from the 4th axis center, it is necessary to reduced speed and acceleration/deceleration appropriately. The overhang distance is limited depending on the payload and operating condition.

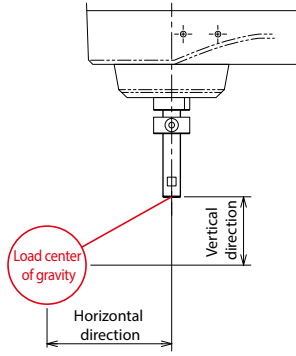

Horizontal direction	Vertical direction
120mm or less	100mm or less

Acceleration/Deceleration Setting Guidelines

The SCARA Robot IXA cannot operate continuously at the maximum acceleration/deceleration or maximum speed specified in the catalog. To operate at the maximum acceleration/deceleration, set a stop time referring to the continuous operation duty guideline graph. If a continuous operation is required, do so within the continuous operation guideline range shown in the acceleration/deceleration setting guideline graph.

- 1) For a PTP operation, always use the WGHT command in the program to set the weight and moment of inertia. For the SCARA robot, the maximum acceleration/deceleration for each payload is set at 100%. When the payload differs, the operation time will also vary even at the same acceleration/deceleration or speed setting.
- 2) Adjust the acceleration/deceleration setting value by gradually increasing it from the continuous operation reference value.
- 3) If an overload error occurs, lower the acceleration/deceleration as required, or set a stop time by referring to the continuous operation duty guideline.
- 4) Duty (%) = (Operation time / (Operation time + Stop time)) x 100
- 5) When moving the robot horizontally at high speed, operate the vertical axis as close to the upward end as possible.
- 6) Set the moment of inertia and payload to the allowable value or lower.
- 7) The load mass represents the moment of inertia and weight at the center of rotation of the 4th axis.
- 8) Operate the robot at an appropriate acceleration/deceleration according to the weight and moment of inertia for the 4-axis specification. Otherwise, the drive section may become prematurely unusable or damaged, or vibration may occur.
- 9) If the load moment of inertia is high, vibration may occur in the vertical axis, depending on the position of the vertical axis. In such a case, decrease the acceleration/deceleration for operation as required.

PTP Operation

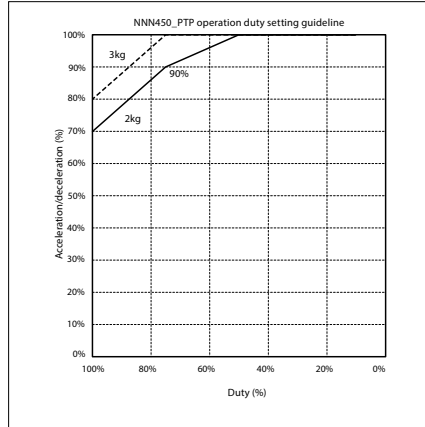
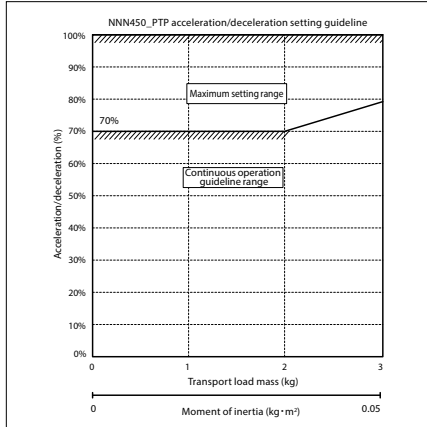

CP Operation

Horizontal

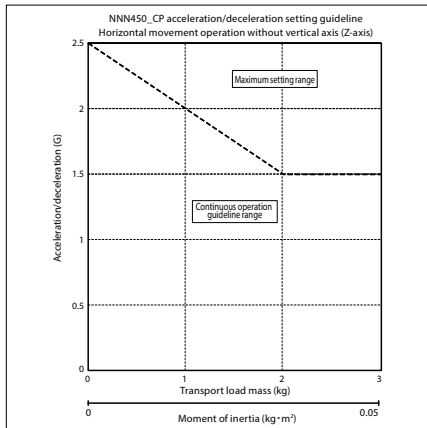

Vertical

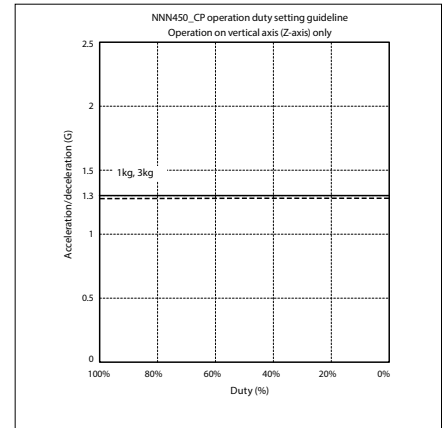
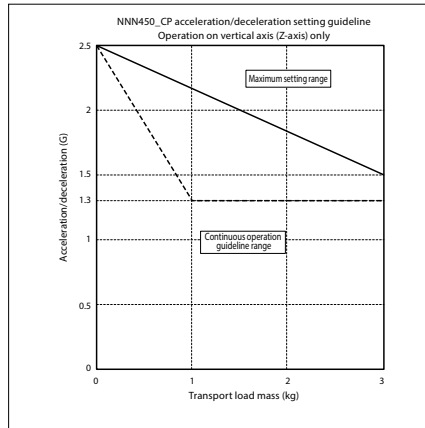

CP operation: Acceleration/deceleration Limitations

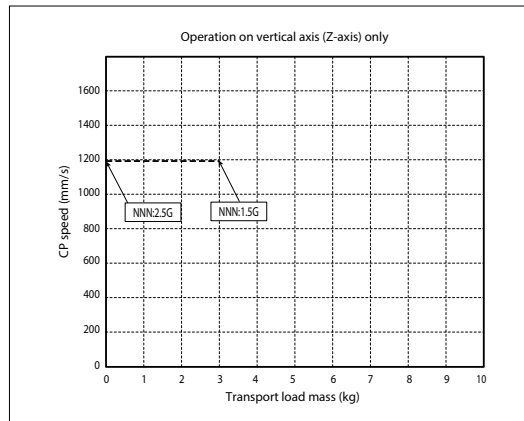
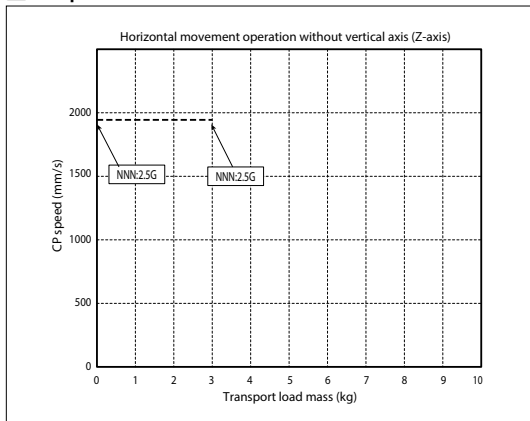

IXA-3NNN4518_4NNN4518

(Note) Refer to P51 (Note 9) for cable connections

CAD drawings can be downloaded from our website.
www.intelligentactuator.com



S.T.: Stroke
M.E.: Mechanical end
S.E.: Stroke end

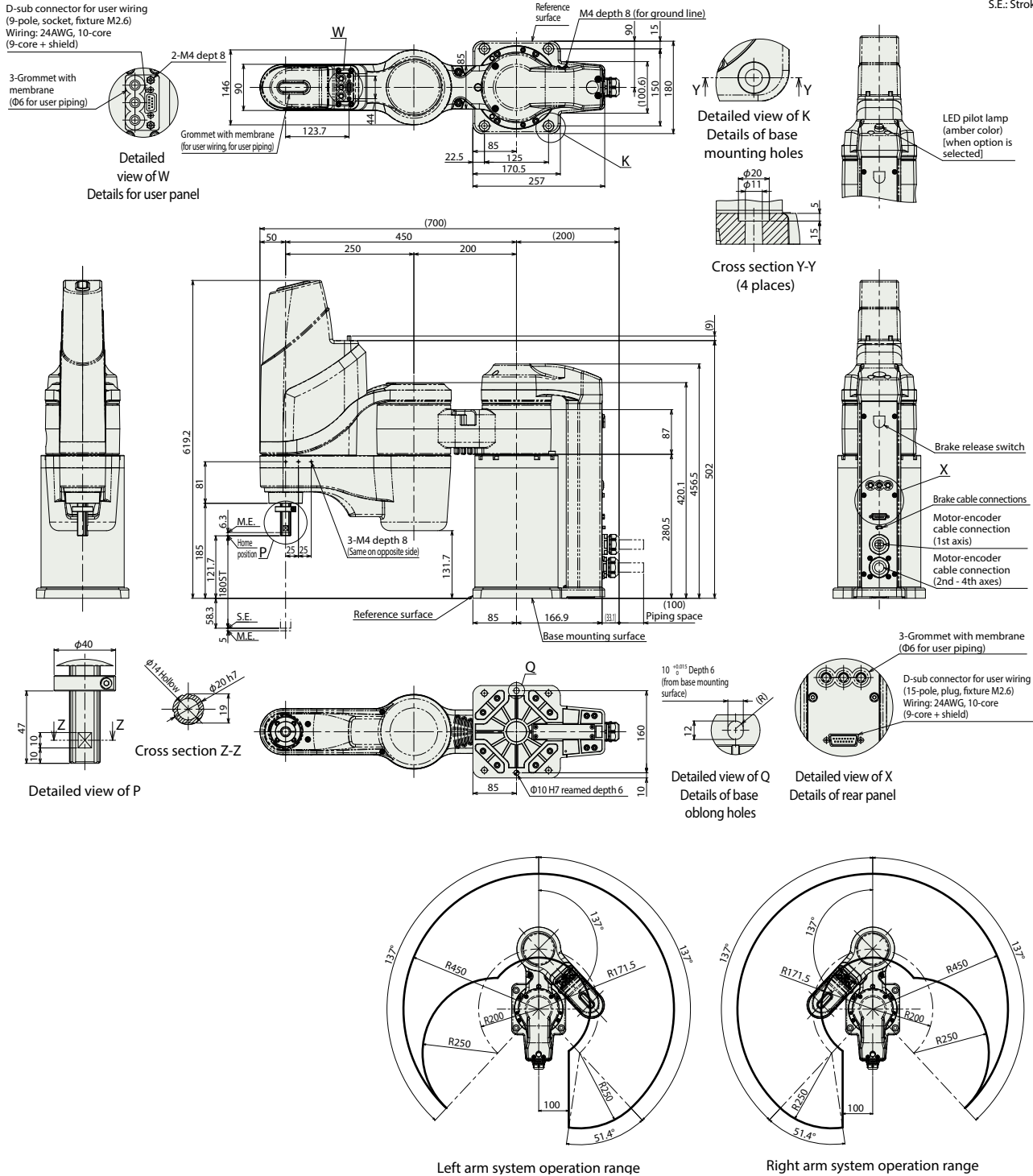

Mass

Item	Description	Mass
Mass	3-axis specification	25.5kg
	4-axis specification	27.0kg

IXA-3NNN4533_4NNN4533

(Note) Refer to P51 (Note 9) for cable connections

D-sub connector for user wiring
(9-pole, socket, fixture M2.6)
Wiring: 24AWG, 10-core
(9-core + shield)

3-Grommet with membrane
(Φ6 for user piping)

2-M4, depth 8

Grommet with membrane
(for user wiring, for user piping)

Detailed view of W
Details for user panel

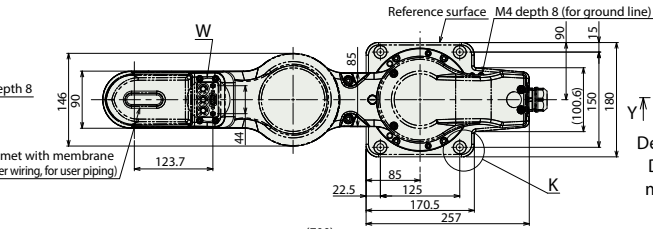
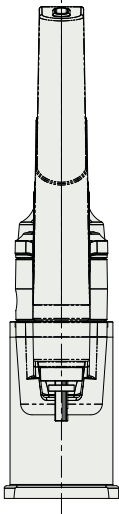

Detailed view of K
Details of base mounting holes

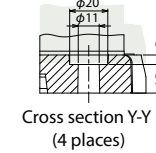

Cross section Y-Y
(4 places)

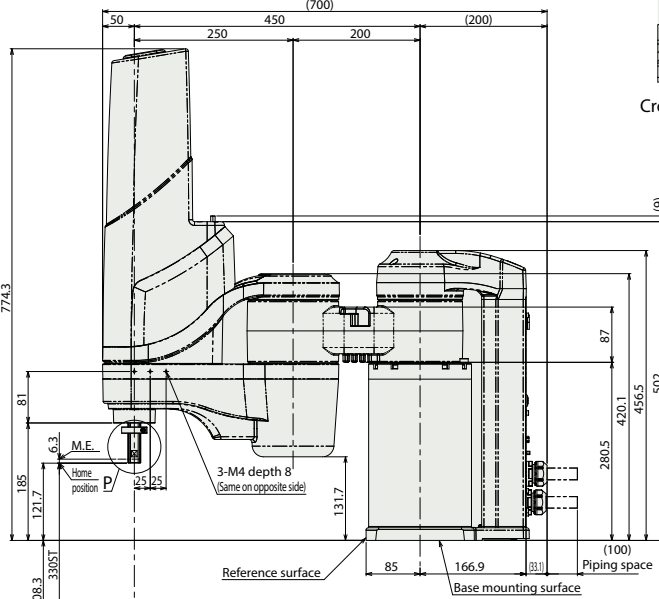
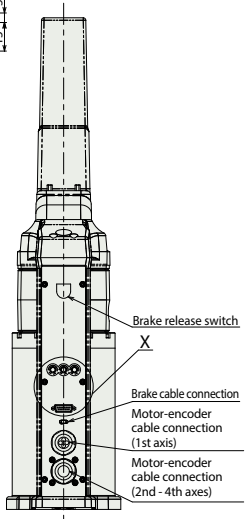
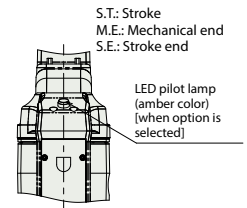

Reference surface
Base mounting surface

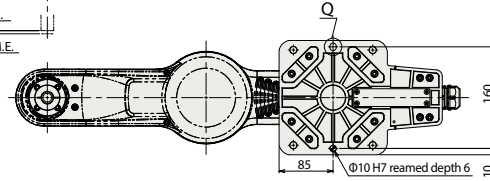

10^{+0.01} Depth 6
(from base mounting surface)

Detailed view of Q
Details of base oblong holes

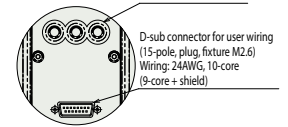

Detailed view of X
Details of rear panel

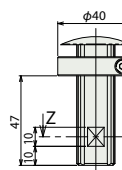

Detailed view of P

Cross section Z-Z

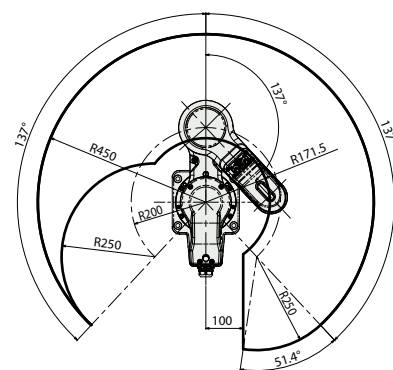

Left arm system operation range

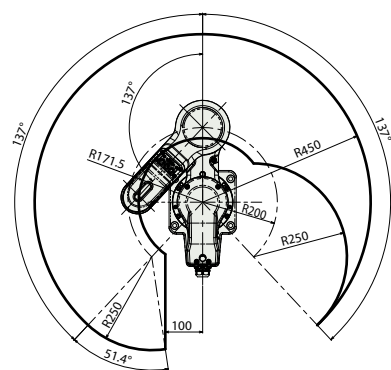

Right arm system operation range

Mass

Item	Description	Mass
Mass	3-axis specification	26.0kg
	4-axis specification	27.5kg

Applicable controller

The actuator on this page can be operated by the controller indicated below.

Name	External view	Max. number of connectable axes	Power supply voltage	Control method													Max. number of positioning points	Reference page
				Positioner	Pulse train	Program	Network* option											
				DV	CC	CIE	PR	CN	ML	ML3	EC	EP	PRT	SSN	ECM			
XSEL-RAX/SAX		8	3-phase AC200V	—	—	●	●	●	—	—	—	—	●	●	—	—	36666 (Depending on the type)	54

(Note) Up to one SCARA robot + one 4-axis robot can be controlled.